

FS-G7P+

User Manual

FLYSKY

Automatic Frequency Hopping Digital System



Copyright ©2025 Flysky Technology Co., Ltd.



微信公众号



Bilibili



Website



Facebook





Thank you for purchasing our products.

Read the manual carefully to ensure your personal safety as well as the safety of your equipment.

If you encounter any problems during using, please refer to this manual first. If the problem is still not resolved, please contact the local dealer directly or contact the customer service staff via the website below:

www.flysky-cn.com

Contents



1.Safety	1
1.1 Safety Symbols	1
1.2 Safety Guide.....	1
2.Product Introduction	2
2.1 Transmitter Overview	2
2.2 Receiver Overview	4
2.2.1 Status LED	4
2.2.2 Connector	4
2.3 Antenna	4
3. Preparation.....	5
3.1 Installing Transmitter Battery	5
3.2 Installing Receiver and Servo.....	5
4. Operation guide.....	6
4.1 Power-on.....	6
4.2 Bind.....	6
4.3 Setting Transmitter LED , Sound and Volume	6
4.4 Calibration	7
4.5 Restoring Factory Settings	7
4.6 Power-off	7
5. System Interface	8
6. Function Menu	9
6.1 Settings-Channel Reverse	10
6.2 Settings-Servo Travel.....	10
6.3 Settings-Neutral Trim.....	11
6.4 Settings-Dual Rate	11
6.5 Settings-Curve	12
6.6 Settings-Smart Vehicle Control (SVC)	12
6.7 Settings-Beginner Mode.....	13
6.8 Settings-ABS	14
6.9 Settings-IDLE UP	15
6.10 Settings-ENG CUT.....	15
6.11 Settings-CH SPEED.....	16
6.12 Auxiliary Channels-CH3 to CH10	16
6.13 Mixes	17
6.14 Mixes - Steering Mixes	17
6.15 Mixing-Programming Mixes.....	17
6.16 Timer.....	18

6.17 Timer – Timer	18
6.18 Timer-Lap List	18
6.19 Switch Assignment.....	18
6.20 Receiver Settings.....	19
6.21 Receiver Settings-Failsafe	19
6.22 Receiver Settings - Bind Settings.....	20
6.23 Receiver Settings - LOW SIGNAL ALARM	21
6.24 Receiver Settings - TELEMETRY LOSS	21
6.25 Receiver Settings - Range Test.....	22
6.26 Receiver Settings - Sensor.....	22
6.27 Receiver Settings - ESC Settings.....	22
6.28 Receiver Settings -i-BUS Settings FS-CEV04	23
6.29 Model	24
6.30 System Settings	25
6.31 System Settings - System Settings	25
6.32 System Settings - Stick Calibration	26
6.33 System Settings - Firmware Update	26
6.34 System Settings - Factory Reset	27
6.35 System Settings - Help Center	27
6.36 System Settings - About	27
7. Product Specifications.....	28
7.1 Transmitter Specifications FS-G7P+	28
7.2 Receiver Specifications FS-R11P	29
8. Packing List.....	30
9. Certification	31
9.1 DoC Declaration	31
9.2 CE Warning.....	31
9.3 FCC Statement	31
9.4 Environmentally Friendly Disposal	32

1. Safety

1.1 Safety Symbols

Pay close attention to the following symbols and their meanings. Failure to follow these warnings could cause damage, injury or death.

 Danger	<ul style="list-style-type: none">• Not following these instructions may lead to serious injuries or death.
 Warning	<ul style="list-style-type: none">• Not following these instructions may lead to major injuries.
 Attention	<ul style="list-style-type: none">• Not following these instructions may lead to minor injuries.

1.2 Safety Guide



Prohibited



Mandatory



- **Do not use the product at night or in bad weather like rain or thunderstorm. It can cause erratic operation or loss of control.**
- **Do not use the product when visibility is limited.**
- **Do not use the product on rain or snow days. Any exposure to moisture (water or snow) may cause erratic operation or loss of control.**
- **Interference may cause loss of control. To ensure the safety of you and others, do not operate in the following places:**
 - Near any site where other radio control activity may occur
 - Near power lines or communication broadcasting antennas
 - Near people or roads
 - On any body of water when passenger boats are present
- **Do not use this product when you are tired, uncomfortable, or under the influence of alcohol or drugs. Doing so may cause serious injury to yourself or others.**
- **The 2.4GHz radio band is limited to line of sight. Always keep your model in sight as a large object can block the RF signal and lead to loss of control.**
- **Do not touch any part of the model that may generate heat during operation, or immediately after use. The engine, motor or speed control, may be very hot and can cause serious burns.**



- **Misuse of this product may lead to serious injury or death. To ensure the safety of you and your equipment, read this manual and follow the instructions.**
- **Make sure the product is properly installed in your model. Failure to do so may result in serious injury.**
- **Make sure to disconnect the receiver battery before turning off the transmitter. Failure to do so may lead to unintended operation and cause an accident.**
- **Ensure that all servos operate in the correct direction. If not, adjust the direction first.**
- **Make sure the model stays within the systems maximum range to prevent loss of control.**



微信公众号



Bilibili



Website



Facebook

2.Product Introduction

This product uses the 2.4 GHz ANT(Ant protocol) enhanced automatic frequency hopping digital system, consisting of FS-G7P+ transmitter and FS-R11P receiver. It has an output of 10 channels, compatible with model cars, boats, etc.

2.1 Transmitter Overview

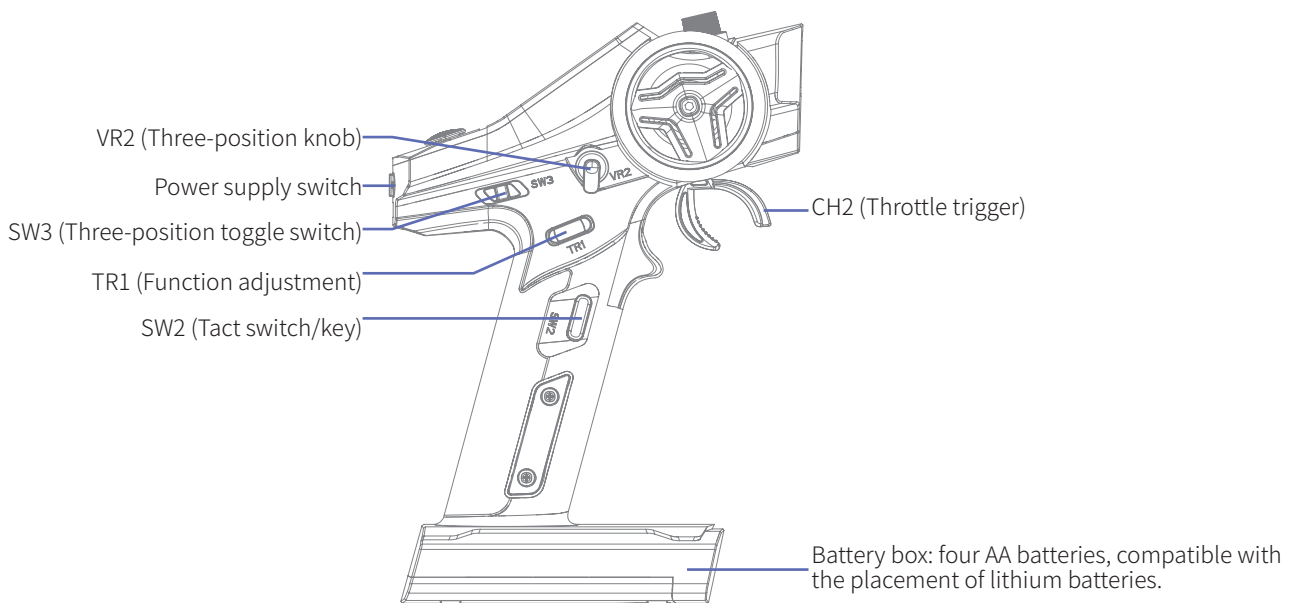
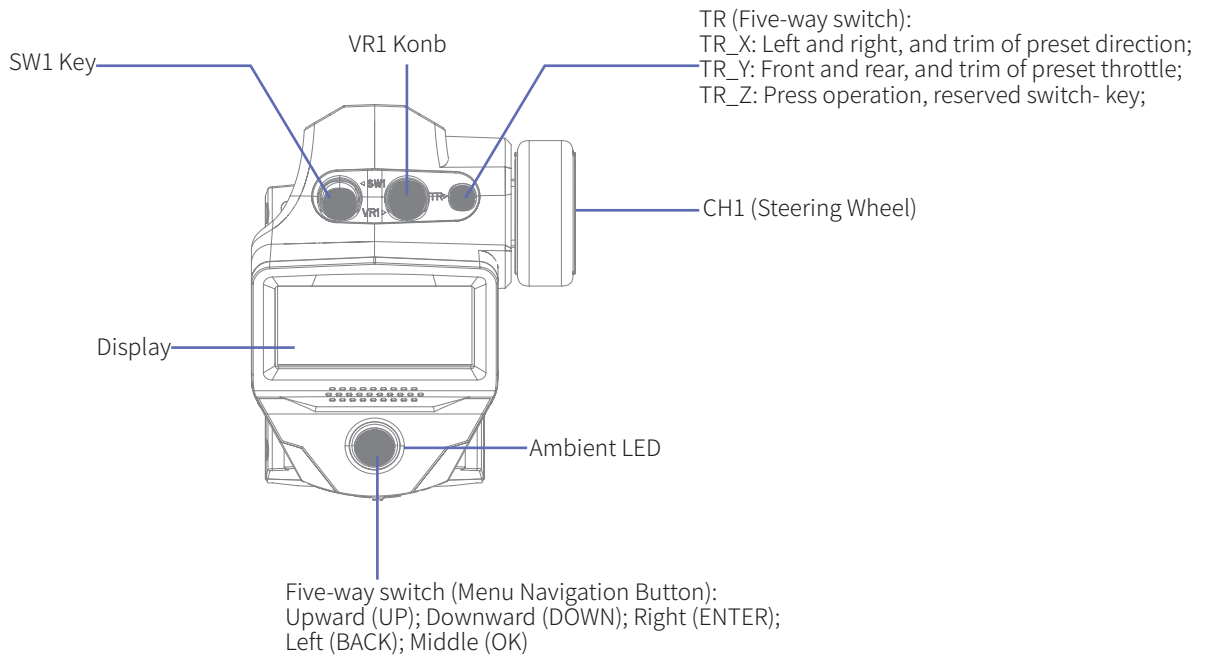

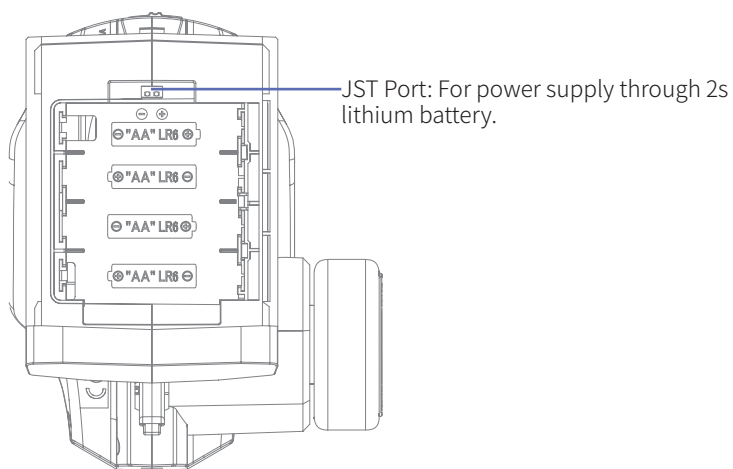
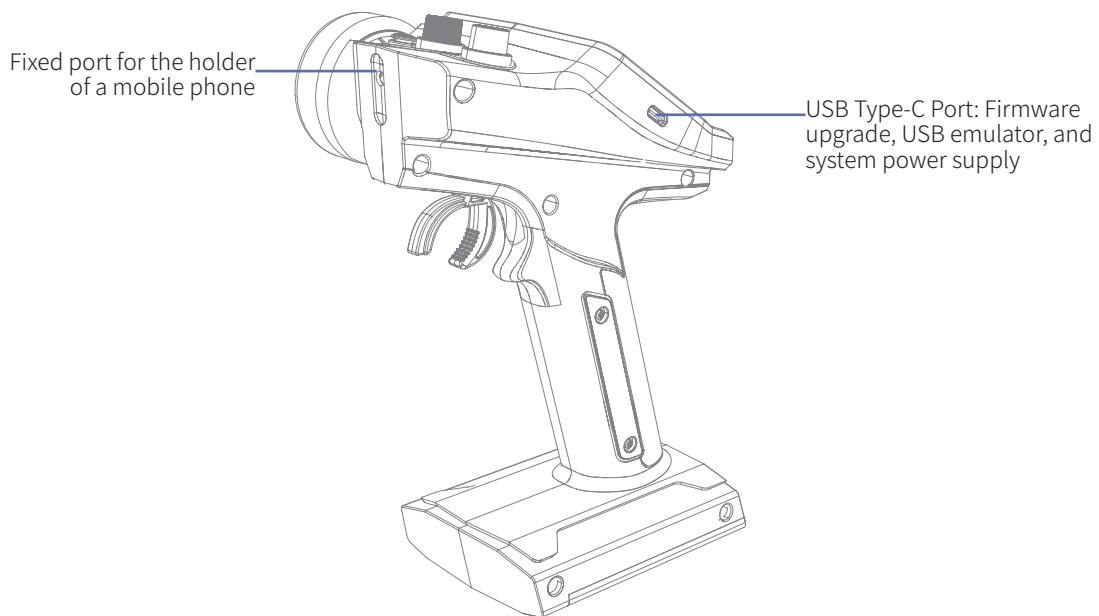

微信公众号



Bilibili



Website



Facebook

2.2 Receiver Overview

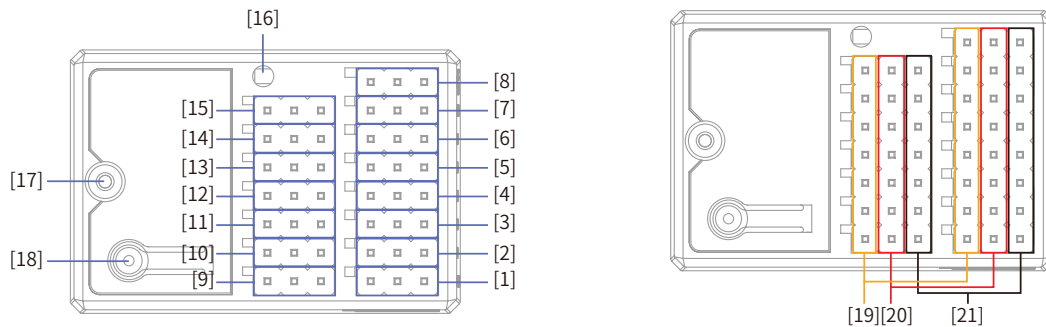

[1]	CH1/P(PWM/PPM)	[12]	CH10
[2]	CH2	[13]	CH11
[3]	CH3	[14]	SENS Connector
[4]	CH4	[15]	SERVO Connector
[5]	CH5	[16]	LED
[6]	CH6	[17]	Antenna
[7]	BIND Connector	[18]	BIND Button
[8]	VCC/BVD (Power Supply/Battery Voltage Connector)	[19]	Signal Pin
[9]	CH7	[20]	"+" (Connect to Battery Anode)
[10]	CH8	[21]	"-" (Connect to Battery Cathode)
[11]	CH9		

2.2.1 Status LED

The LED status indicates the power supply state of the receiver and its working state.

Off: The receiver is not powered on.

Solid ON: The receiver works normally.

Fast Flashing: The receiver is in the binding mode.

Slow Flashing: The transmitter bound is powered off, or it has been not bound with a transmitter, or the receiver does not receive any signal.

Three-flash-one-off: The receiver is in the forced update mode.



2.2.2 Connector

All channel connectors are 2.54mm*3 Pin standard pins, and connectors are used to connect the receiver to the various components of the model.

Note:When using, please pay attention to the indicator marks on the receiver to ensure correct operation. Some marks may be located on the side of the receiver. Please operate according to the direction indicated by the marks to avoid misuse or damage to the equipment.

2.3 Antenna

It is an external antenna.







 Caution	<ul style="list-style-type: none"> Do not pull the antenna of the receiver. Do not tie the antenna and the servo cable together.
 Warning	<ul style="list-style-type: none"> Do not put the antenna close to the metal materials, because this will affect the signal strength of the receiver. Keep the receiver's antenna at least 1cm away from conductive materials such as carbon or metal.



3. Preparation

Prior to operations, please install the battery and connect devices according to the sequence and guide as described in this chapter.

3.1 Installing Transmitter Battery

 Danger	• Only use specified battery (X4 AA batteries).
 Danger	• Do not open, disassemble, or attempt to repair the battery.
 Danger	• Do not crush/puncture the battery, or short the external contacts.
 Danger	• Do not expose to excessive heat or liquids
 Danger	• Do not drop the battery or expose to strong shocks or vibrations.
 Danger	• Always store the battery in a cool, dry place.
 Danger	• Do not use the battery if damaged.

Battery type: AA batteries or 2S lithium batteries JST Connector inside the battery compartment.

Please follow the steps below to install the transmitter batteries:

1. Open the battery compartment cover.
2. Put 4 AA batteries with sufficient electricity into the battery compartment. Ensure that the metal terminals on the batteries contact the metal terminals inside the battery compartment. You should choose the proper size of 2S 7.4V lithium battery to access the JST Connector. Connect them correctly.
3. Cover the battery compartment.

3.2 Installing Receiver and Servo

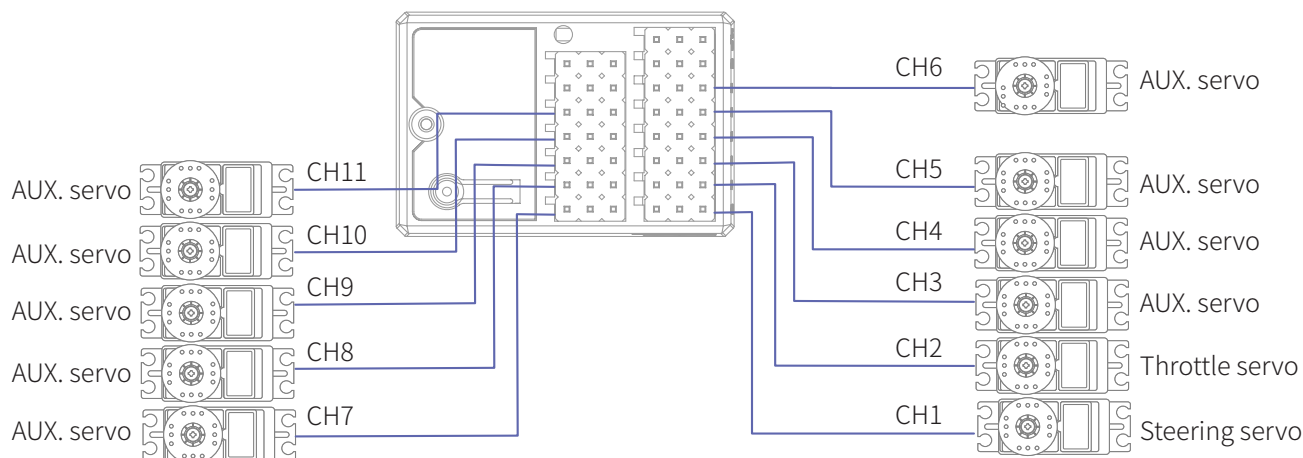

微信公众号



Bilibili



Website



Facebook



4. Operation guide

After the preparation is completed, you can start to use the product according to the guide in this chapter.

4.1 Power-on

Power on the product according to the following steps:

1. Check the system status to make sure the battery is fully charged and properly installed.
2. Turn the switch to the [On] position. The screen will light up.
3. Power on the receiver.

 Warning	• At this point, the system starts. Please operate carefully. Otherwise, it may cause damage to the product or injury to people.
 Warning	• For your safety, please turn the transmitter switch and throttle to the safe position.

4.2 Bind

The ex-factory bind settings of the transmitter and receiver are completed successfully. If you need to replace the transmitter or receiver with another one, please follow the steps below for binding. The receiver supports **TWO WAY** binding and **ONE WAY** binding. The transmitter will display the information returned from the receiver after the **TWO WAY** binding is finished. And the default is **ONE WAY** binding, the steps are as below:

1. Power on the transmitter, then select **RX SET > BIND SET > STRAT** to put the transmitter into bind state.
2. Connect the power cable to the **BVD/VCC** connector on the receiver. At this time, the receiver LED flashes slowly.
3. Press and hold the **BIND** button on the receiver for more than 3 seconds or press and hold the **BIND** key on the receiver for power-on.
4. After the receiver LED becomes slow flashing, then manually put the transmitter to exit the binding state. At this time, the receiver LED is solid on indicating the binding is successful.
5. Verify that the transmitter and receiver are working properly. If you need to re-bind, repeat the above steps.

Note: If **TWO WAY** mode is selected at the transmitter side, when the receiver LED status changes from fast-flashing to solid-on, the binding is successful.

- | |
|---|
| • The procedure is applicable to the bind between only FS-G7P+ transmitter and FS-R11P receiver. The bind methods vary with receivers. For details about the operations, you can visit the FLYSKY official website to obtain the receiver manual or other related information. |
| • Since the product is constantly updated, please visit the FLYSKY official website to obtain the latest transmitter and receiver compatibility list. |

This product system is compatible with most of our ANT Protocol receiver models. The details are as follows:

RF standard: 2.4 GHz Ant protocol

Receiver model: FS-R11P

4.3 Setting Transmitter LED , Sound and Volume

This LED is a monochromatic light. You can set the ON and OFF state. You can enable or disable the sound for the



system operations and alarms. For system operations and alarms, you can enable/disable the sound separately or collectively. In addition, you can set the sound volume separately.

Please follow the steps below to perform the settings:

1. Start the transmitter and enter the SYSTEM menu. In the SYSTEM settings, set the LED, SOUND, and VOLUME.
2. After the settings are completed, return back.

4.4 Calibration

The calibration is required in case of data offset of the transmitter due to physical wear in long-term operations. At this time, we need to calibrate the output data and neutral angle of the traversing steeringwheel, throttle trigger, VR1 and VR2.

The transmitter has been calibrated at the factory. If you need to recalibrate it, please follow the steps below to perform the settings:

1. Power on the transmitter, enter the system menu, and select the stick calibration function. Follow the prompts to press the Start key for calibration.
2. Swing the steeringwheel and trigger to the maximum and minimum travel in each direction respectively and then release them. Turn VR1 to its maximum and minimum travel and then back to the neutral position. Toggle the VR2 left and right repeatedly to the maximum extent for two or three times. Finally, toggle the VR2 back to the neutral position.
3. Press the return key to exit the calibration interface. The calibration is complete. If the pop-up window indicates that the calibration has failed, it means that the control to be calibrated has not reached the maximum and minimum travel, or VR1 and VR2 has not been toggled to the middle position. The re-calibration is required.

4.5 Restoring Factory Settings

When you want to clear the data in the transmitter, you can restore all data in the transmitter to default values. That is, all model data and settings are restored to the default state.

Please follow the steps below to restore factory settings:

1. Power on the transmitter, enter the system menu, and select the factory reset function. Follow the prompts to press the OK button to start the reset.
2. After the successful reset, the system automatically returns and stays in the system menu interface. It indicates that the system has been restored to the factory settings.

4.6 Power-off

Please follow the steps below to power off the system:

1. Power off the receiver.
2. Turn the switch to the OFF position to turn off the transmitter.



Caution

- When you shut down the system, make sure to power off the receiver, and then the transmitter. Otherwise, the model may be damaged and people may be injured.



微信公众号



Bilibili



Website



Facebook

5. System Interface

Main system interface

Enter the main system interface after power-on.

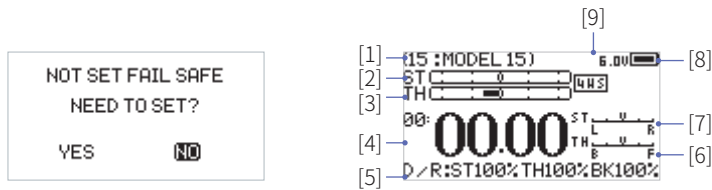

[1]	Model name and model number	[6]	Throttle trim display
[2]	Steering channel(ST) output display	[7]	Steering trim display
[3]	Throttle channel(TH) output display	[8]	Transmitter voltage display
[4]	Timer	[9]	Signal and strength
[5]	DR output display		

The timer display area of the main interface can be set to display signal strength and BVD voltage information. The steps are the following.

1. Press and hold the MIDDLE key of the five-way key for 2S to select the timer display area.
2. Press the MIDDLE key of the five-way key to access the HOME DISPLAY menu, then select SENSOR > OK.

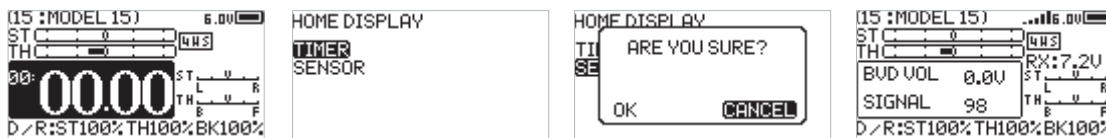

Sub-page 1

After power-on, enter the main system interface and press the UP key. Press the return key to return to the main system interface.



Sub-page 2

After power-on, enter the main system interface and press the DOWN key. Press the return key to return to the main system interface.

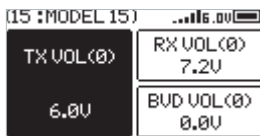

It can set the sensors displayed on Sub-page 2 including name, ID, and value. The setting steps are as follows.

1. Enter the main system interface and press the DOWN key to access Sub-page 2.
2. Press the MIDDLE key of the five-way key to access the SELECT SENSOR menu, then select the sensor you want to display.



6. Function Menu

Function description:

In this transmitter, we have classified the functions and made a new layout. There are 8 categories in icons in total. That is: Setup(SET), Auxiliary Channel(AUX.CH), MIXES, TIMER, Switch Assignment(SW ASSIGN), Receiver Settings(RX SET), MODEL, System Setup(SYSTEM SET). After the classification, it will become more convenient and easy to set up the model.



SET

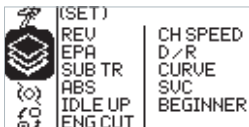

AUX.CH



MIXES



TIMER

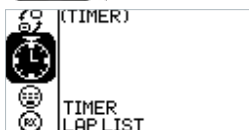

SW ASSIGN

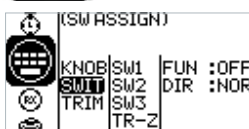

RX SET



微信公众号



Bilibili



Website



Facebook



MODEL



SYSTEM SET

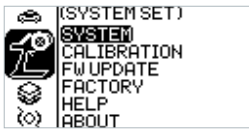

Function operations:

In the main interface, press the OK key to enter the function menu. Select the function category by pressing the UP/DOWN key. Press the OK key to enter the corresponding next-level menu.

6.1 Settings-Channel Reverse

Function: Perform the reverse processing of the output data of one channel or more channels. This function is used in debugging the model.

Application: When the model is designed, there may be no way to determine the unified standard. When we assemble and debug a model, we find that the operation model is reversed to our requirement. For example, the model moves left when we want it to move right. At this time, the transmitter signal output needs to be adjusted. The channel reverse function is used to adjust the action direction of each servo or motor and output signals.

Function settings:

1. In the SET menu, select the REV(channel reverse) function and press the OK key to enter
2. Select the channel you need to adjust by the pressing UP/DOWN key. Press the OK key to enter the edit state. Then adjust it by the pressing UP/DOWN key. Press return after adjustment.
3. Test the function to confirm all the servo or motor action direction is the same as the actually expected direction.

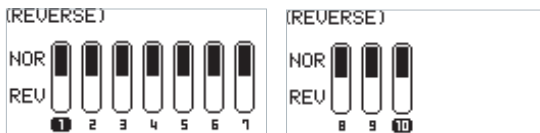

6.2 Settings-Servo Travel

Function: Adjust the travel amount of the servo output. This function is used in debug. This function can be used to set the travel of the left and right up/down/H/L at both ends of the channel respectively.

When the model is designed, there are changes in the size of the structure and the specification may not be unified. In addition, there may be different sizes of operator's habitual actions. The servo travel function can be used to set the travel amount required for each channel to adjust the



corresponding structure for the best match, to obtain the required operation effect. For example: You want to operate that the turning action is not so large, you can adjust the value of the direction channel at both ends to be smaller. In this way, the turning action should be smaller, with less likely to be tailspin.

Function settings:

1. In the SET menu, select the EPA(servo travel) function and press the OK key.
2. Select the channel you need to adjust by the pressing UP/DOWN key. Press the OK key to enter the edit state. Then adjust it by the pressing UP/DOWN key. Press return after adjustment.
3. Test the function to confirm all the servo or motor action directions are the same as the actual expected travels.

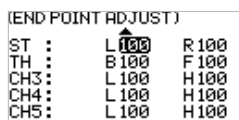

6.3 Settings-Neutral Trim

Function: Set and adjust the neutral data of each channel.

This function is mainly used for the trim of the model in assembly and debugging. For example, the vehicle is stationary and the transmitter traversing handwheel is in the neutral position; if you find that the wheels deviate from the straight direction, it can be easily corrected through this function. At this time, it is difficult and inconvenient to adjust the model structure.

Note: Before setting this function, make sure that the channel is moving in the correct direction.

Function settings:

1. In the SET menu, select the SUB TR(neutral trim) function and press the OK key.
2. Select the channel you need to adjust by the pressing UP/DOWN key. Press the OK key to enter the edit state. Then adjust it by the pressing UP/DOWN key. Press return after adjustment.
3. Observe and test the function to ensure that the settings work as expected.

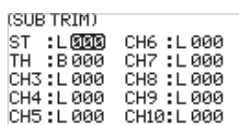

6.4 Settings-Dual Rate

Dual rate allows you to quickly adjust the output value of certain channels to achieve the best manipulation effect. The rate function can be used to set the direction channel channel 1, throttle channel channel 2 upper, brake channel 2 lower channel, and output data rate. The range is 0-100%. You can also set the switch-on and switch-off. The two control modes can be switched through the application switch setting, see the Key Setting menu.

Function settings:

1. In the SET menu, select the D/R(Dual rate) function and press the OK key.
2. Select the channel you need to adjust by the pressing UP/DOWN key. Press the OK key to enter the edit state. Then adjust it by the pressing UP/DOWN key. Press return after adjustment. In the adjustment, observe by operating the corresponding channel handwheel and throttle trigger.
3. Verify the function to confirm that all channel outputs operate normally as expected.

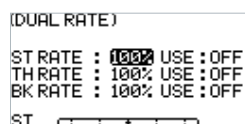

微信公众号



Bilibili



Website



Facebook

6.5 Settings-Curve

Curve function is used to set the output data curve adjustment of the direction channel channel 1, throttle channel channel 2 upper, and brake channel 2 lower channel. The range is -100 to +100. It can change the output sensitivity of each channel. When the data is bigger, the sensitivity of the middle position is bigger and the two end positions are smaller. It is vice versa when the data is smaller.

Function settings:

1. In the SET menu, select the CURVE function and press the OK key.
2. Select the channel to be adjusted by pressing the UP/DOWN key. Press the OK key to enter the edit state. Select the EXP by pressing the UP/DOWN key and press the OK key. Then press UP/DOWN key to adjust the data. After adjustment, press the return key. If you need to enable this function, select the USE item by pressing the UP/DOWN key, and press the OK key to enter the edit state. Press UP/DOWN key to switch on. Then press the return key.
3. Test the function to confirm that the adjusted channel output operates normally as expected.

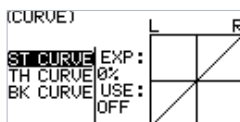

6.6 Settings-Smart Vehicle Control (SVC)

The SVC function should be used with the FS-R7V receiver.

USE: Turns on or off the function.

MESIAN CAL: Used for gyroscope to calibrate steering and throttle neutral to make the best driving condition when the vehicle is driving normally.

Before enabling the SVC function, you need to adjust the vehicle's steering servo volume, neutral trim and throttle neutral to the best driving condition. After completion, start the [Smart Vehicle Control] function for neutral calibration. Every time you change the trim or throttle curve, you need to calibrate the neutral position. The steering throttle should be placed in the neutral stationary state during the calibration process.

ESP MODE: Used for model assisted stability. Two modes are available: Normal/Lock.

[Normal]: When the vehicle is yawing or steering, the gyroscope automatically provides an opposite compensation to control the servo to keep it stable or prevent drifting according to the angular velocity generated.

[Lock]: If the steering wheel is return-to-center, the gyroscope will control the servo in the opposite direction according to the yaw angle when the vehicle is yawing, to make it go back to the expected direction (if the steering wheel is not return-to-center in the "Lock mode", it will be the same as the "Normal mode").

REVERSE: You can set the channel direction when the gyroscope mixes with the steering channel.

ST GAIN: Used to change the sensitivity of the mixing steering channel. And the setting range is between 0% and 100%.



TH GAIN: Used to change the mixing throttle channel sensitivity. And the setting range is between 0% and 100%.

PRIORITY: Used to set the control ratio between steering wheel control and gyroscope in the steering, i.e., turning radius. In direction turning by using the steering wheel, the steering angle will be reduced due to the influence of gyroscope mixing. When the value is 0%, the mixing control is the strongest, that is, the turning radius is the largest. When the value is 100%, the mixing control is 0, that is, the turning radius is the smallest. And the setting range is between 0% and 100%.

CMG CAL: Used for the first time to enable the gyroscope via binding or gyroscope calibration required after replacement. The model keeps a stable and stationary state. Click CMG CAL. The receiver LED flashes twice, and a menu appears at the transmitter side for prompting the calibration is successful.

Function settings:

1. In the SET menu, select the SVC function and press the OK key.
2. Select a function item to be adjusted by pressing the UP/DOWN key. Press the OK key to enter the edit state. Then press UP/DOWN key to adjust the data or select an appropriate item. After adjustment, press the return key. If you need to enable this function, select the USE item by pressing the UP/DOWN key, and press the OK key to enter the edit state. Press UP/DOWN key to select ON to switch on. Then press the return key.

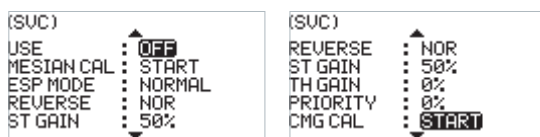

6.7 Settings-Beginner Mode

The beginner mode function is used to set the output limit of direction channel and throttle channel. After this function is enabled, the channel output is only 50%. In this way, the beginner can easily drive the vehicle under the condition of limiting the speed and turning angle.

Function settings:

1. In the SET menu, select the BEGINNER function and press the OK key.
2. Select the item you need to adjust by pressing the UP/DOWN key. Press the OK key to enter the edit state. Then adjust it by pressing the UP/DOWN. Press return after adjustment.
3. Test the function to confirm that all channel outputs operate normally as expected.

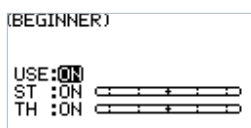

微信公众号



Bilibili



Website



Facebook

6.8 Settings-ABS

This function can be used to set pulse braking, namely the brakes are released periodically when braking is triggered, to prevent skid, drift or under-turning due to locked wheels.

There are seven items for A.B.S. function setting, including USE, RETURN, DELAY, CYCLE, POINT, DUTY, and ST MIXING.

USE: To turn on or off the function. Set it to on to turn on the function, and the default is OFF.

RETURN: Controls the reduction of braking during each pulse. It can be set to any value between 0% and 100%, and the step value is 1%. By default it is set to 50%. If set to 60%, when the brakes are active; the system will remove 60% of the brakes strength on each pulse. When it is set to 100%, there is no brake.

DELAY: Determines how long it takes for the A.B.S. system to take effect. It can be set to any value between 0% and 100%, and the step value is 1%. By default it is set to 0%. At a setting of 0%, the A.B.S. system will take effect as soon as the brake is applied. The higher the value, the longer it will take for the A.B.S. to function. When set to 0% there will be no delay, meaning the breaks will be applied as soon as they are triggered. The maximum setting of 100% will result in a delay of 2 seconds.

CYCLE: It is used to set the interval between pulses. The setting range is 20% to 100%, and the step value is 1%. The default value is 50%. The larger the value, the longer the interval time between pulses. The value 100% indicates the interval is 0.5S.

POINT: It is used to set the start position of pulse brake function. The setting range is 10% to 100%, and the step value is 1%. The default value is 30%. The higher the value, the closer the stick position that triggers the pulse brake function is to the full brake position. 0%-100% is the entire travel movement amount of the throttle trigger.

DUTY: To set the braking - release cycle length in pulse braking between -4 and +4. Default: 0, that is, the time for release the brake and the brake are same, when the value is changed, the peak and trough lengths of the brake pulse's square wave change accordingly. You can adjust the ratio between braking and release. The rate is 1:1 when the cycle length is set to "0". The rate is 1:2 when the cycle length is set to "1". And the rate is 2:1 when the cycle length is set to "-1". A.B.S. can be reduced automatically while turning. This function mixes braking and steering to turn reduce the A.B.S. or replace it with a constant braking pressure. The percentage represents the trigger position through its entire range of movement. E represents inside, N represents outside; if 50% N is set, the ABS function is active when within 50% (10%N-50% N), and outside 50% (50% N-100% N) is to turn off the ABS function; If 50% E is set, the ABS function will be turned off within 50% (10%E-50% E), and the ABS function will be turned on outside 50% (50% E-100% E).

Function settings:

1. In the SET menu, select the ABS function and press the OK key.
2. Select the item you need to adjust by pressing the UP/DOWN key. Press the OK key to enter the edit state. Then adjust it by pressing the UP/DOWN. Press return after adjustment.
3. Test the function to confirm that all channel outputs operate normally as expected.

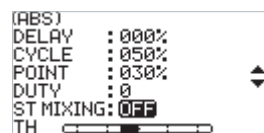
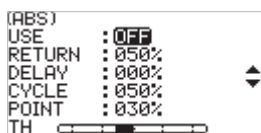

6.9 Settings-IDLE UP

The throttle idle up function is used to set the engine idle speed when the fuel car is in the neutral position. After setting the idle speed, you can preheat the engine in order to keep it from stalling.

There are three items for IDLE UP function setting, including USE, TYPE, and RATE.

USE: To turn on or off the function.

TYPE: Select a mode between NORMAL and LOCKING, For NORMAL mode, when pulling the trigger backwards, the channel data continues to decrease. For LOCKING mode, the channel output data is locked at the value set when pulling the trigger backwards.

RATE: To set a value for IDLE UP. It can be set to any value between -50% and 50%, and the step value is 1%. By default it is set to 0%.

Function settings:

1. In the SET menu, select the IDLE UP function and press the OK key.
2. Select the item you need to adjust by pressing the UP/DOWN key. Press the OK key to enter the edit state. Then adjust it by pressing the UP/DOWN. Press return after adjustment.
3. Test the function to confirm that all channel outputs operate normally as expected.

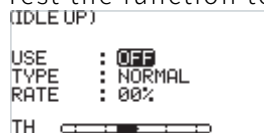

6.10 Settings-ENG CUT

When Engine Cut is triggered, the throttle channel will output the predefined value, and the throttle trigger cannot control the output value of the throttle channel.

There are two items for it, including USE and RATE.

USE: To turn on or off the function.

RATE: To set a predefined value for ENG CUT. It can be set to any value between -100% and 100%, By default it is set to 0%. And the step value is 1%.

Function settings:

1. In the SET menu, select the ENG CUT function and press the OK key.
2. Select the item you need to adjust by pressing the UP/DOWN key. Press the OK key to enter the edit state. Then adjust it by pressing the UP/DOWN. Press return after adjustment.
3. Test the function to confirm that all channel outputs operate normally as expected.



微信公众号



Bilibili



Website



Facebook

6.11 Settings-CH SPEED

This function allows you to set the steering speed, forward speed and brake speed. The minimum delay is 0.00S, and maximum delay is 10.00S, and the default is set to 0.00S. The djustment step is 0.02S.

ST: To set steering response speed. It can set respectively the speed when steeringwheel is turning or steeringewheel is returning to neutral positon.

FRONT: To set response speed when moving forwards. It can set respectively the speed when throttle is forwarding or returning to neutral positon.

BRAKE: To set response speed when moving backwards or braking. It can set respectively the speed when throttle is moving backwards/braking or returning to neutral positon.

Function settings:

1. In the SET menu, select the CH SPEED function and press the OK key.
2. Select the item you need to adjust by pressing the UP/DOWN key. Press the OK key to enter the edit state. Then adjust it by pressing the UP/DOWN. Press return after adjustment.
3. Test the function to confirm that all channel outputs operate normally as expected.

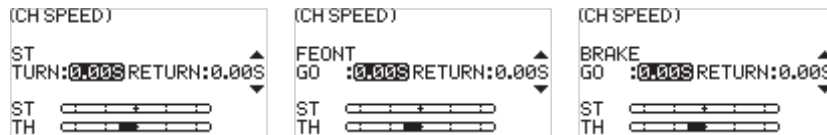

6.12 Auxiliary Channels-CH3 to CH10

For some models with complex functions, we provide up to 10 channels of output, 8 of which are auxiliary channels for the most effective control of multiple functions in different ways. The Auxiliary Channels function is used to set the control settings for CH3 to CH10, assigning targeted controls to the channels for operation.

Function settings:

1. In the AUX.CH menu, select CH3 to CH10 and press the OK key.
2. Select the item you need to adjust by pressing the UP/DOWN key. Press the OK key to enter the edit state. Then adjust it by pressing the UP/DOWN. Press return after adjustment.
3. Test the function to confirm that all channel outputs operate normally as expected.



6.13 Mixes

Mixes is enabled for some models that require two channels to act in conjunction with each other. The Mixing channel function provides 1 steering mixes plus 5 programmable mixes.

Function settings:

In the main interface, press the OK key to enter the function menu. Select the MIXES menu by pressing the UP/DOWN key, and press the OK key to enter the edit state.



6.14 Mixes - Steering Mixes

This is a special function mixing. The ST MIXING(Steering Mix) provides two types of mixing, that is, TRACK(track-specific) mixer and 4WS mixer.

The 4WS mixer provides 4 different schemes for front and rear wheels to meet the different requirement scenarios for different vehicles.

Function settings:

1. In the MIXES menu, select the ST MIXING and press the OK key.
2. Select the item you need to adjust by pressing the UP/DOWN key. Press the OK key to enter the edit state. Then adjust it by pressing the UP/DOWN. Press return after adjustment.
3. Test the function to confirm that all channel outputs operate normally as expected.

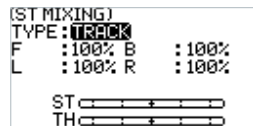

6.15 Mixing-Programming Mixes

The programming mixes function is used to mix the output data of any channel to another channel in a certain rate, to achieve a desired mixing effect.

Function settings:

1. In the MIXES menu, select a MIX and press the OK key.
2. Select the item you need to adjust by pressing the UP/DOWN key. Press the OK key to enter the edit state. Then adjust it by pressing the UP/DOWN. Press return after adjustment.
3. Test the function to confirm that all channel outputs operate normally as expected.

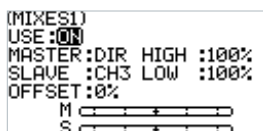

微信公众号



Bilibili



Website



Facebook

6.16 Timer

Timer menu provides two functions: TIMER and LAP LIST.

Function settings:

In the main interface, press the OK key to enter the function menu. Then select the TIMER menu by pressing the UP/DOWN key. Press the OK key to enter the edit state.

6.17 Timer – Timer

The Timer function is used for timing in races, including counting, countdown, and lap counting. You can also use it to test a tank of fuel or a full battery and confirm the usage time. In the alarm parameter setting, you can set the alarm prompt time when the timer starts. For example, set to 05M00S. This means the alarm will start when the countdown reaches 5 minutes.

Function settings:

1. In the TIMER menu, select the TIMER and press the OK key.
2. Select the item you need to adjust by pressing the UP/DOWN key. Press the OK key to enter the edit state. Then adjust it by pressing the UP/DOWN. Press return after adjustment.
3. Test the function to confirm that all setting outputs operate normally as expected.

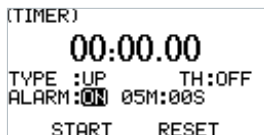

6.18 Timer-Lap List

The data display page is available only when you use the lap counting function. You can view the entire duration, the fastest lap time, and the average lap time. Thus, you can easily judge and adjust the operation to finally achieve a good result. The start and stop of the lap time can be set through the Key Setting menu see Key Setting menu for details.

Press and hold the Middle button of the Five-way switch until a pop-up menu comes along, then select OK, afterwards press the Middle button to clear the timer-lap list.

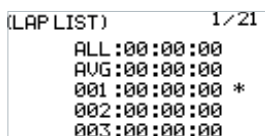

6.19 Switch Assignment

The key setting function is to assign switches to some functions in order to control the output of the actions needed through the specified switch. According to the types, it includes trim, switch, and knob.

Function settings:

1. In the SW ASSIGN (switch assignment) menu, select a item and press the OK key.
2. Select the item you need to adjust by pressing the UP/DOWN key. Press the OK key to enter the edit state. Then adjust it by pressing the UP/DOWN. Press return after adjustment.
3. Test the function to confirm that all channel outputs operate normally as expected.

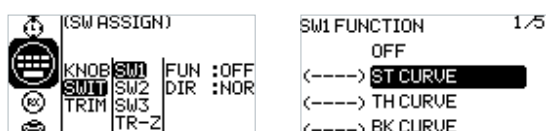

6.20 Receiver Settings

The RX SET(receiver setting) menu provides a number of function setting menus to allow you to set up the receiver system in all aspects. That is, FAILSAFE, BIND SET, LOW SIGNAL ALARM, TELEMETRY LOSS, RANGE TEST, SENSOR, ESC SET, and I-BUS SET.

Function settings:

In the main interface, press the OK key to enter the function menu. Select the RX SET(receiver setting) menu by pressing the UP/DOWN key. Press the OK key to enter the function setting interface.



6.21 Receiver Settings-Failsafe

The failsafe function is used when the receiver loses radio signal and is out-of-control. The receiver performs channel output according to the set failsafe value to protect the safety of the model and personnel.

RESPONSE TIME

Used to set the failsafe judgment time, the setting range is from 250ms to 1000ms. The default is 300ms.

Function settings:

Press the OK key to enter the edit state, then set the failsafe judgment time by pressing the UP/DOWN key. After the settings are completed, just press the back key.

For i-BUS/PPM/PWM signal. It can be set to Not Set, OFF or ON.

Not Set: The failsafe has not been set, and there is no output in case of out-of-control.

OFF: It is no output for i-BUS/PPM/PWM channel.

ON: i-BUS/PPM/PWM channel output respectively the set value. Namely, you can set a value respectively for each channel from 1 to 10. By default, this value is the reading of current channel output value.

Function settings:

- In the FAILSAFE menu, select [I-BUS/PPM/PWM: NOT SET] by pressing the UP/DOWN key;
- Press the OK key to enter the edit state, then select [ON], the system will pop up a prompt interface, then adjust the corresponding controls to the desired positions and hold them if needed. Select [OK] on the pop-up prompt interface, all channel failsafe value settings have been completed.
- To set an individual channel, select the channel to be set, press the OK key to enter the edit state.
- Select the appropriate value or adjust the corresponding control to the desired position and hold it, just press the back key.

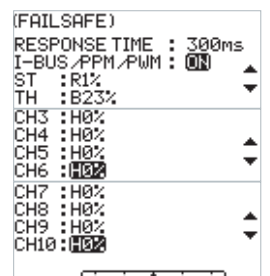
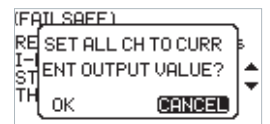
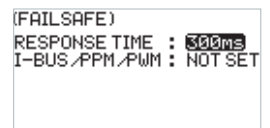

Notes:

- Because the S.BUS signal information contains failsafe flag bits, the failsafe information can be transmitted to the subsequent devices by the failsafe flag bits rather than by no output state. The subsequent devices gives response according to the analysed information for the failsafe flag bits.
- For the signal PWM/PPM/i-BUS without failsafe flag bits, it supports the setting of the output signal to OFF in case of failsafe, transmitting the failsafe information to the subsequent devices by no output state.
- It is Not Set by default, then the receiver will not output when RC signal is lost.



微信公众号



Bilibili



Website



Facebook

6.22 Receiver Settings - Bind Settings

The transmitter and the receiver have been bound with each other before delivery and can be operated directly. If you want to replace the receiver, you need to bind the new receiver with the transmitter by using the binding function before they can be operated normally.

Five parameters - RF system, RF type, receiving type, output mode, frequency - and a BIND key are provided for setting purpose.

RF SYS: To set between Fast and Routine. As for Routine mode, if the transmitter RF system is set to Routine, it has strong anti-interference capacity for other models which are located in the same environment and the closer distance. And for Fast mode, if the transmitter RF system is set to Fast, then it has strong coexistence capacity among the same model transmitters which are located in the same environment and the closer distance, and it has lower latency.

RF type: There are two options available, ANT1WAY one-way and ANT2WAY two-way. If you are using a two-way receiver, it is recommended to select ANT2WAY two-way, which may bring you a better experience with more information feedback.

ANT1WAY means a one-way mode. In this mode, only the transmitter gives commands to the receiver; while the receiver outputs and performs commands received from the transmitter. The advantage is that it can ensure simultaneous operation by more users on the same site with less interference.

ANT2WAY means a two-way mode, which enables intercommunication between the transmitter and the receiver to be configured with the corresponding functions, so that the basic information of the model can be provided to the user in real time. For example, if you want to know the battery voltage of the model vehicle, you can enable this option and bind the receiver configured with this function, then you can read the battery voltage value on the transmitter.

Receiver type: Two options are available, namely standard receiver and two-in-one receiver, which can be selected according to the receiver you are using. The option of two-in-one receiver means a receiver configured with a ESC; however, standard receivers are supplied by default. For details, please visit our website to learn more about relevant models.

Output mode: There are four optional output modes (combination of two output modes), i.e., PWM/SBUS, PPM/IBUS, PWM/IBUS, PPM/SBUS four output modes, which can be selected according to actual needs.

Servo frequency: There are three optional output modes, i.e., analog, digital and others, which can be selected according to the type of servo. The digit following each option is used to set the frequency of the servo output.

Note: The frequency of analog servos, digital servos and other servos are 60HZ, 380HZ and 50HZ-400HZ respectively.

Function settings:

1. In the BIND SET menu, select the item to be adjusted by pressing the UP/DOWN key and press the OK key for editing. Set the desired value by pressing the UP/DOWN key and press the OK key to confirm the adjustment.
2. After the adjustment and setting are completed, select START by pressing the UP/DOWN key and press the OK key to bind with the receiver. For details, please refer to the chapter for binding operation and the Quick Start Guide.
3. After finishing the above step, carry out a test to confirm that all channel outputs are functioning as expected.

```
(BIND)
RF SYS  : Routine
RF STD  : ANT 2 WAY
RX TYPE : STANDARD
OUTPUT  : PWM/IBUS
FREQUENCY: ANALOG
```

```
(BIND)
RF STD  : ANT 2 WAY
RX TYPE : STANDARD
OUTPUT  : PWM/IBUS
FREQUENCY: ANALOG
BINDING : START
```



6.23 Receiver Settings - LOW SIGNAL ALARM

This function is used to set up the alarm feature for signal strength when the transmitter and receiver communicate in two-way mode.

You can set a specific alarm threshold for signal strength, whether to enable alarm sound, and whether to enable repeated alarms and set the time interval for repeated alarms.

After setting the alarm function, when the receiver's signal strength is lower than the set value, the transmitter sends out a low signal alarm according to the setting method.

Function settings:

1. In the LOW SIGNAL ALARM menu, select [USE] > [ON], just press the back key.
2. Select [Sound] by pressing the UP/DOWN key, press the OK key to enter the edit state, and select [ON] or [OFF], just press the back key.
3. Select [ALARM VAL] by pressing the UP/DOWN key, press the OK key to enter the edit state, then set the appropriate value by pressing the UP/DOWN key, just press the back key.
4. Select [REPETITION] by pressing the UP/DOWN key, press the OK key to enter the edit state, then set the appropriate time by pressing the UP/DOWN key, just press the back key.

```
(LOW SIGNAL ALARM)
USE      : OFF
```

```
(LOW SIGNAL ALARM)
USE      : ON
SOUND    : OFF
ALARM VAL : 40
REPETITION : 10S
```

6.24 Receiver Settings - TELEMETRY LOSS

Used to set the alarm function when the transmitter does not receive the information returned by the receiver. You can set whether to turn on the [TELEMETRY LOSS], whether to turn on the [SOUND], and the time to trigger the alarm (Sensitivity).

Function settings:

1. In the TELEMETRY LOSS menu, select [USE] > [ON], just press the back key.
2. Select [Sound] by pressing the UP/DOWN key, press the OK key to enter the edit state, and select [ON] or [OFF], just press the back key.
3. Select [SENSITIVITY] by pressing the UP/DOWN key, press the OK key to enter the edit state, then set the appropriate time by pressing the UP/DOWN key, just press the back key.

```
(TELEMETRY LOSS)
USE      : OFF
```

```
(TELEMETRY LOSS)
USE      : ON
SOUND    : OFF
SENSITIVITY : 3.0S
```



微信公众号



Bilibili



Website



Facebook

6.25 Receiver Settings - Range Test

As an important function, it is recommended to conduct the range test before each operation to check whether the remote controller is functional or environmental conditions are normal.

Working principle: It is aimed to conduct a narrow-ranged test by actively reducing the power of the transmitter, in order to realize quick inspection of the transmitter system and the environment. There are three parameters (power, signal, RSSI) displayed and indicated on the transmitter interface.

Function settings:

1. In the RANGE TEST menu, directly press the SW2 key to conduct the test.
2. You should keep the transmitter still during the test, but you can move your model at this time. If there is no problem in the test within a certain range, the device can be used normally.

```
(RANGE TEST)
PRESS SW2 TO REDUCE!
POWER:DEC
SIG :NULL
RSSI :NULL
```

6.26 Receiver Settings - Sensor

As an interesting feature for two-way communication systems, sensors can be used to send back some information you need through the receiver.

Our transmitter can support up to 15 different types of returned data to provide you with the feedback of seven basic parameters, i.e., TX VOL(TX voltage), RX VOL(RX voltage), BVD VOL(BVD voltage), SIGNAL(signal intensity), NOISE, SNR(noise rate) and RSSI. BVD: detect an external power supply. It is recommended to use this function to monitor the battery voltage and give an alarm in case of a failure.

Function settings:

In the SENSOR menu, scroll pages by pressing the UP/DOWN key to check relevant information.

```
(SENSOR)
ID  TYPE  VALUE
0  TXVOL  5.0V
```

Note: The transmitter is compatible with i-BUS sensors, such as FS-CPD01 magnetic speed sensor, FS-CPD02 optical speed sensor, FS-CVT01 voltage sensor, FS-CTM01 temperature sensor and FS-CAT01 altitude sensor.

6.27 Receiver Settings - ESC Settings

The ESC SET(ESC Setting) menu is an additional option provided specially for FLYSKY two-in-one ESC, which is used to set the two-in-one governor more precisely to ensure its optimal performance. To enable this setting, you need to switch the receiver type to the two-in-one option in the Receiver settings - Bind Setting menu.

Three parameters, namely operating mode, battery type, and drag braking force can be setup here. There are two braking modes as follows: the first mode is FOR/BRK/REU that means, the device moves forward when pressing the trigger for acceleration; it is braked when pulling the trigger backward and then reverses when releasing the trigger to the neutral position and then pulling it backward again; and the second mode is forward/reverse that means, the device moves forward when pressing the trigger for acceleration, and it reverses immediately when pulling the trigger backward. These two modes can be set according to actual needs.



Function settings:

1. In the ESC SET menu, select the item to be adjusted by pressing the UP/DOWN key and press the OK key for editing. Set the desired value by pressing the UP/DOWN key and press the OK key to confirm the adjustment.
2. After that, carry out a test to confirm that all set channel outputs are functioning as expected.

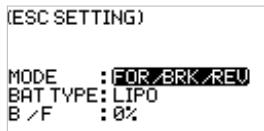

6.28 Receiver Settings -i-BUS Settings FS-CEV04

The i-BUS SET(i-BUS setting) function is a unique and powerful serial communication protocol system provided by FLYSKY. It can be output to any channel by setting. For receivers with i-BUS interface and corresponding accessories, see the description of serial bus receivers for details.

Function settings:

1. The transmitter and receiver are completed successfully;
2. Connect the input cable of the FS-CEV04 Serial Bus Receiver to the SERVO port of the receiver;
3. Connect the servo to the C1-C4 ports of the FS-CEV04 Serial Bus Receiver;
4. Turn on the transmitter to enter the i-BUS SET interface, and select the channel to be assigned; if the channel is incorrect, select "CANCEL" to re-set;

Note: If the interface prompts to set the RF type to "ANT TWO WAY" first, set the RF type to ANT TWO WAY first.

5. Press the corresponding button on the i-BUS receiver. After the setting is successful, the system will pop up a pop-up window showing the interface number of the currently selected channel assigned to the i-BUS receiver.
6. Repeat the above steps to set more channels.

Note: If the receiver is overloaded, please supply power separately to prevent the wire from being burnt out due to excessive current.

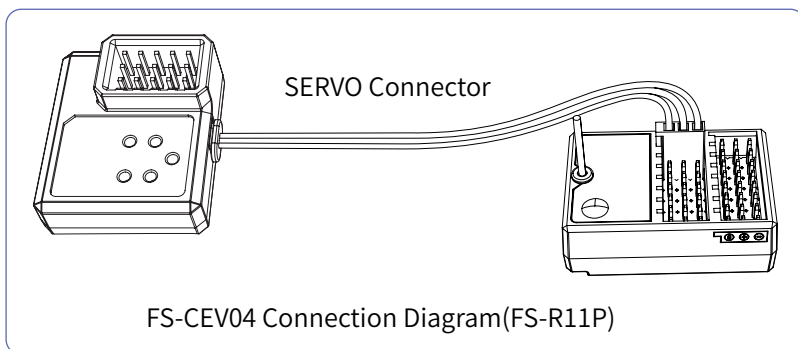
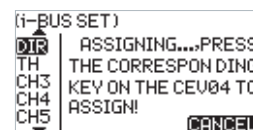
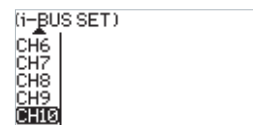

微信公众号



Bilibili



Website



Facebook

6.29 Model

Used to set model-related functions.

Model Select

Used for selecting and switching models. The FS-G7P+ can store up to 20 models.

After selection, use UP/DOWN to choose a model from the list. Press the OK key, the system will display a prompt pop-up window. Finally, select [OK] by pressing the UP/DOWN key to save the settings.

- Transmitter is in two-way communication with the receiver, a safety prompt window will be displayed. Then select "OK" in the prompt window to switch successfully.

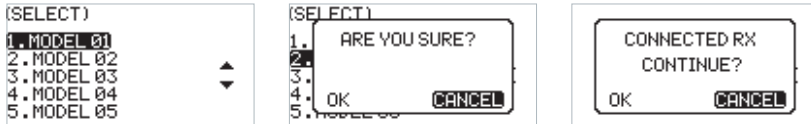

Model Name

Set the name of the current model.

After selection, use UP/DOWN to choose letters, characters or numbers, set the desired name. Then select [OK] by pressing the UP/DOWN key to save the settings.

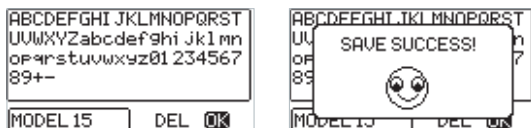

Copy

Used to copy the current model to the target model group. If you have a new model that is the same or similar to the model you used before, you can use this function to make a copy for quick setting.

After selection, use UP/DOWN to select the model to be copied, press the OK key, and then choose the model number for copy by pressing the UP/DOWN key, select [OK], the system will display a prompt pop-up window, then select [OK] by pressing the UP/DOWN key to save the settings.

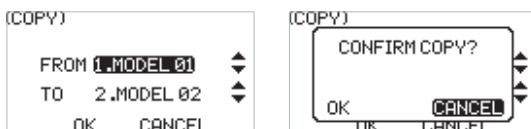

Reset

Used to reset all model datas for the current model.

After selection, the system will display a prompt pop-up window, then select [OK] by pressing the UP/DOWN key.

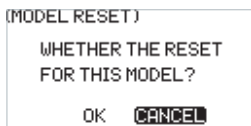

RACE MODE

This function is used to quickly disable the LOW SIGNAL ALARM and TELEMETRY LOSS, effectively turning off the related signal alarms. It is recommended to use this function to disable the Low signal alarm and Telemetry Loss before the race; after the race, you can decide whether to re-enable these two alarm functions based on the actual usage scenario.

Function settings:

In the MODEL menu, use UP/DOWN to select [RACE MODE], and the system will pop up a message indicating the setting is successful; select [OK] to close the popup window.

If you select [RACE MODE] again, a pop-up message will indicate that the system is already in race mode, meaning the relevant alarms have been disabled; select [OK] to close the popup window.

Note: When the receiver is not in communication with the transmitter, if the [RACE MODE] is selected, the RF STD will automatically be adjusted to [ANT 1 WAY], and at the same time, the RF system will switch to [Routine]; When the receiver is in one-way communication with the transmitter, if the [RACE MODE] is selected, the RF system will switch to [Routine].

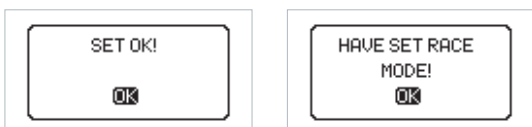

6.30 System Settings

The System menu includes six function submenus, i.e., system settings, stick calibration, firmware update, factory reset, help center and about.

Function settings:

In the System menu, select the item to be set by pressing the UP/DOWN key and press the OK key to enter the corresponding function submenu.

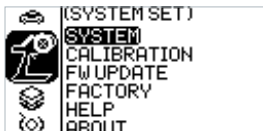

6.31 System Settings - System Settings

The system setting function is used to set the transmitter system, including setting the language, idle alarm time, battery type, display contrast & brightness, LED light, screen time, system sound failsafe and volume.

Description of battery type:

AA battery means a widely-used R6 alkaline dry battery. 2S means two lithium-ion cells, which are non-standard specialized battery. Please consult specialists before use to avoid error alarms or dangers of over-discharge or over-heating! No other batteries are recommended.



微信公众号



Bilibili



Website



Facebook

Function settings:

In the SYSTEM SET menu, select the item to be set by pressing the UP/DOWN key and press the OK key for editing. Set the desired value by pressing the UP/DOWN key and press the OK key to confirm the adjustment.

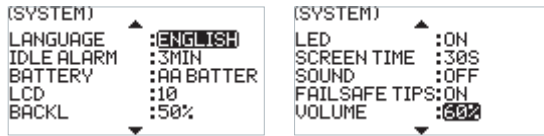

6.32 System Settings - Stick Calibration

The CALIBRATION(stick calibration) function is used to restore the data of the neutral position and endpoints, which are changed for certain reasons after the transmitter has been used for a long time. The ST, TH and VR2 channels can be recovered by using this function please refer to the chapter for stick calibration.

Function settings:

1. In the CALIBRATION menu, turn the steering wheel left and right to the maximum and return it to the neutral position; pull the trigger back and forth and return it to the neutral position; and turn VR1 to its maximum travel and return it to the neutral position, then turn VR2 left and right to the maximum travel and return it to the neutral position; and finally press the OK key to confirm the calibration.
2. Carry out a test to confirm that all channel outputs set after calibration are functioning as

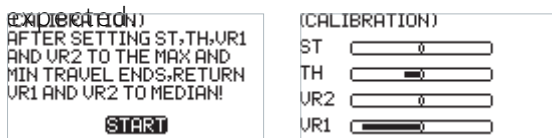

6.33 System Settings - Firmware Update

The FW UPDATE(firmware update) function is used for synchronizing the system to the latest version and experiencing better functions and services when the firmware is upgraded by the manufacturer.

Function settings:

Note: This function is only available in the FlySky Assistant software provided by FLYSKY.

1. In the FW UPDATE menu, a dialog box will pop up. At this time, you can select YES by pressing the UP/DOWN key and press the OK key to start the update session. The current menu will be closed directly once the update session is completed.
2. Carry out a test to confirm that the transmitter functions normally after the update.

Note: Always ensure sufficient power supply for the transmitter when using this function.

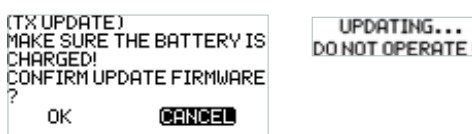

Note: Turn off the transmitter to exit the firmware updating state during the firmware updating process if need.



6.34 System Settings - Factory Reset

The FACTORY(factory reset) function is used to restore the entire transmitter system to the factory settings in case a number of parameters are adjusted incorrectly during operation.

Function settings:

1. In the FACTORY menu, a dialog box will pop up. At this time, you can select YES by pressing the UP/DOWN key and press the OK key to reset the transmitter. The current menu will be closed automatically once the resetting process is completed.
2. Carry out a test to confirm that the transmitter functions normally after it is reset.

Note: When activating this function, all parameters will be reset, including the model data you have saved before. It is important to back up the data first if necessary. For details, please refer to the relevant functions of FlySky Assistant.

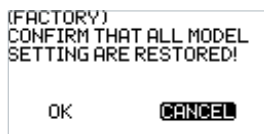

6.35 System Settings - Help Center

The HELP(Help Center) provides a QR code of the user manual. You can use your mobile phone to scan the QR code to retrieve the information you want to know. It enables you to quickly access the electronic version of the user manual if there is no hard copy in hand. You can also find the company website and official media accounts in this menu which may facilitate interactive communication between FLYSKY and customers in future.



6.36 System Settings - About

The ABOUT function submenu is used to display the system firmware and hardware information which can be referred to for future maintenance purposes.



微信公众号



Bilibili



Website



Facebook

7. Product Specifications

This chapter contains the specifications of FS-G7P+ transmitter and FS-R11P receiver.

7.1 Transmitter Specifications FS-G7P+

Product Model	FS-G7P+
Compatible Receiver	FS-R11P(Receivers with ANT Protocol)
Compatible RC Model	Car or boat
Number of Channels	10
RF	2.4GHz ISM
RF Protocol	ANT
Maximum Power	<20dBm (e.i.r.p.) (EU)
Reception Sensitivity	≤ -99dBm
Resolution	4096
Low Voltage Alarm	AA battery: <4.2V/ 2S Lipo battery: <7.2V
Battery	1.5AA*4/2S Lipo (JST)
Data Connector	USB Type-C
Charging Jack	NO
Antenna	Single Built-in Coaxial Cable Antenna
Display	128*64 LCD(Black And White Dot Matrix Screen)
Input Power	4~9V/DC
Firmware Update	Supported
Distance	≥ 300m(Ground Distance Without Interference)
Temperature Range	-10°C ~ +60°C
Humidity Range	20% ~ 90%
Dimensions	136.4*111.8*197.5mm
Weight	305g
Certifications	CE, FCC ID:2A2UNG7PPLUS00



7.2 Receiver Specifications FS-R11P

Product Model	FS-R11P
Compatible Transmitter	FS-G7P+ and other transmitters with ANT protocol
Compatible RC Model	Cars or boats
Number of Channels	11
RF	2.4GHz ISM
Maximum Power	< 20dBm (e.i.r.p.) (EU)
RF Protocol	ANT
Resolution	4096
Data Output	PWM/PPM/i-BUS/S.BUS
Operating Voltage	3.5~9V/DC
Distance	No less than 300m (Ground distance without interference)
Antenna	External single antenna
Display	LED
Firmware Update	Supported
Temperature Range	-10°C ~ +60°C
Humidity Range	20% ~ 95%
Color	Black
Weight	10g
Dimensions	37.0*25*13.3mm
Waterproof	PPX4
Certification	CE, FCC ID:2A2UNR11P00



微信公众号



Bilibili



Website



Facebook

8. Packing List

Transmitter*1 (FS-G7P+)

Receiver*1 (FS-R11P)



9. Certification

9.1 DoC Declaration

Hereby, [ShenZhen Flysky Technology Co., Ltd.] declares that the Radio Equipment [FS-G7P+] and [FS-R11P] are in compliance with RED 2014/53/EU.

The full text of the EU DoC is available at the following internet address: www.flyskytech.com/info_detail/10.html

9.2 CE Warning

The antenna(s) used for this transmitter must be installed to provide a separation distance of at least 20 cm from all persons and must not be co-located or operating in conjunction with any other transmitter. End-users and installers must be provided with antenna installation instructions and transmitter operating conditions for satisfying RF exposure compliance.

9.3 FCC Statement

This equipment has been tested and found to comply with the limits for a Class B digital device pursuant to part 15 of the FCC rules. These limits are designed to provide reasonable protection against harmful interference in a residential installation. This equipment generates, uses and can radiate radio frequency energy and, if not installed and used in accordance with the instructions, may cause harmful interference to radio communications. However, there is no guarantee that interference will not occur in a particular installation. If this equipment does cause harmful interference to radio or television reception, which can be determined by turning the equipment off and on, the user is encouraged to try to correct the interference by one or more of the following measures:

- Reorient or relocate the receiving antenna.
- Increase the separation between the equipment and receiver.
- Connect the equipment into an outlet on a circuit different from that to which the receiver is connected.
- Consult the dealer or an experienced radio/TV technician for help.

To assure continued compliance, any changes or modifications not expressly approved by the party responsible for compliance could void the user's authority to operate this equipment. This equipment complies with Part 15 of the FCC Rules. Operation is subject to the following two conditions:

- (1) This device may not cause harmful interference, and
- (2) This device must accept any interference received, including interference that may cause undesired operation.



微信公众号



Bilibili



Website



Facebook

Caution!

The manufacturer is not responsible for any radio or TV interference caused by unauthorized modifications to this equipment. Such modifications could void the user authority to operate the equipment.

1. The antenna(s) used for this transmitter must be installed to provide a separation distance of at least 20 cm from all persons and must not be co-located or operating in conjunction with any other transmitter. End-users and installers must be provided with antenna installation instructions and transmitter operating conditions for satisfying RF exposure compliance.
2. Move all your channels to the desired position.
3. Select [All channels] and then [Yes] in the confirmation box.

9.4 Environmentally Friendly Disposal

Old electrical appliances must not be disposed of together with the residual waste, but have to be disposed of separately. The disposal at the communal collecting point via private persons is for free. The owner of old appliances is responsible to bring the appliances to these collecting points or to similar collection points. With this little personal effort, you contribute to recycle valuable raw materials and the treatment of toxic substances.



CAUTION

RISK OF EXPLOSION IF BATTERY IS REPLACED BY AN INCORRECT TYPE.
DISPOSE OF USED BATTERIES ACCORDING TO THE INSTRUCTIONS

Figures and illustrations in this manual are provided for reference only and may differ from actual product appearance. Product design and specifications may be changed without notice.



FLYSKY

www.flysky-cn.com

Copyright ©2025 Flysky Technology Co., Ltd.

Date:2025-02-07



微信公众号



Bilibili



Website



Facebook



FCC ID:2A2UNG7PPLUS00

FCC ID:2A2UNR11P00

Manufacturer: ShenZhen FLYSKY Technology Co., Ltd.
Address: 16F, Huafeng Building, No. 6006 Shennan Road, Futian District, Shenzhen, Guangdong, China